

# Moda Shampoo Chair Specifications Sheet



**SKIN+ACT**

Toll Free: 1.800.418.0830

[www.skinact.com](http://www.skinact.com)  
[www.spaandequipment.com](http://www.spaandequipment.com)

International: 818.834.6640

## NOTICE

No part of this document may be photocopied, reproduced, or translated into any other language without prior written consent of Spa and Equipment/SkinAct.

The information in this document is subject to change without notice at any time and should not be construed as a commitment by Spa and Equipment/SkinAct.

Spa and Equipment/SkinAct assumes no responsibility for any errors that may be in this document, nor does it make expressed or implied warranty with regard to this material, including, but not limited to, the implied warranties of merchantability and fitness for a particular purpose.

Spa and Equipment/SkinAct shall not be liable for incidental or consequential damages arising out of the furnishing, performance, or use of this document and the program material which it describes.

# SKIN+ACT

Toll Free: 1.800.418.0830

[www.skinact.com](http://www.skinact.com)  
[www.spaandequipment.com](http://www.spaandequipment.com)

International: 818.834.6640

# Measurements

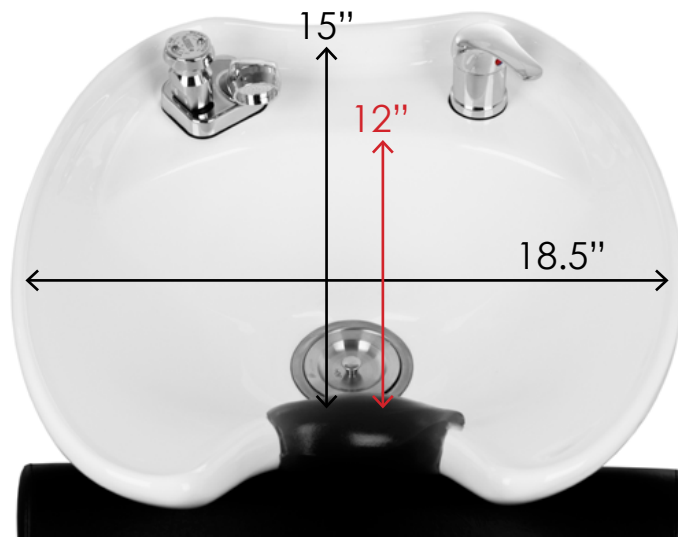
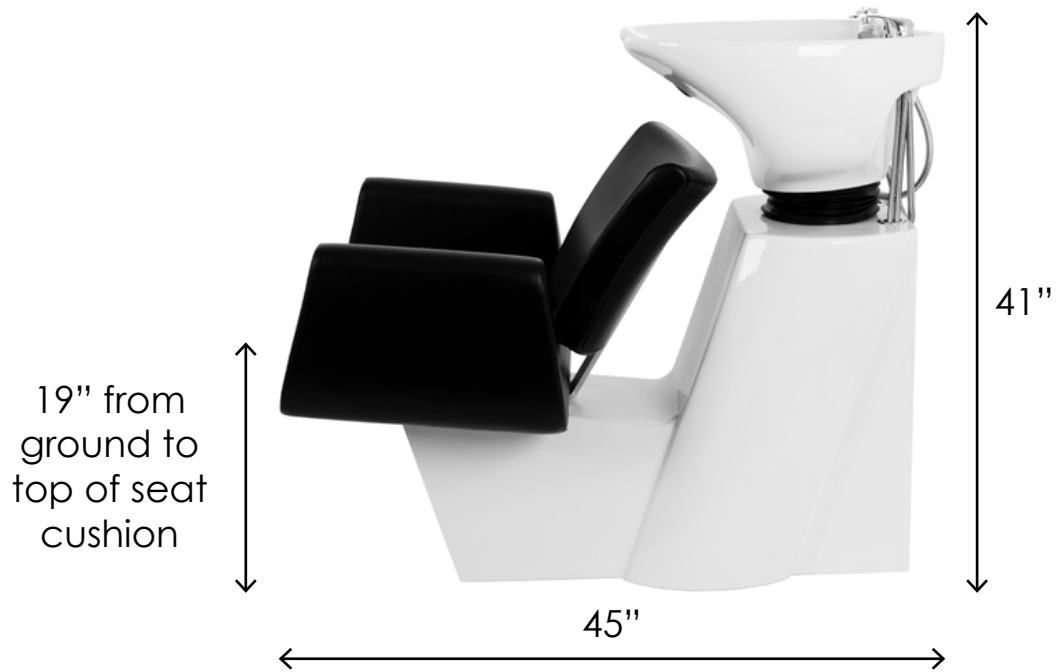

# Measurements



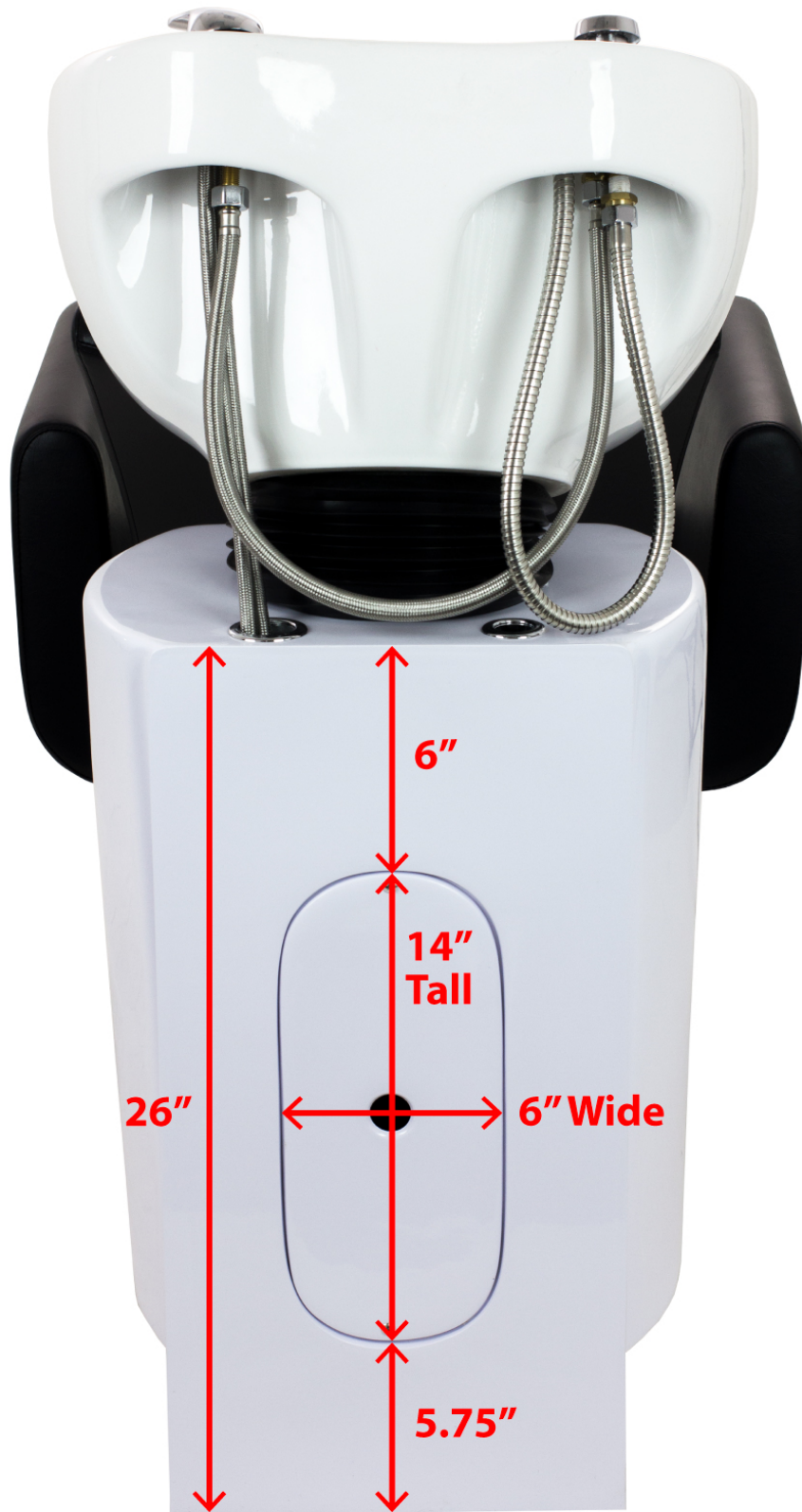











Drain

Hot & Cold Water  
Pipes (back of  
shampoo chair)



## Part List

Drainer Hose 1 pc.	Rubber Ring 1 pc.	Bowl 1 pc.
		
Water Screen 1 pc.	Sprayer Cap 1 pc.	Chair 1 pc.
		
Nut 4 pcs.	Screw 4 pcs.	
		

## Installation

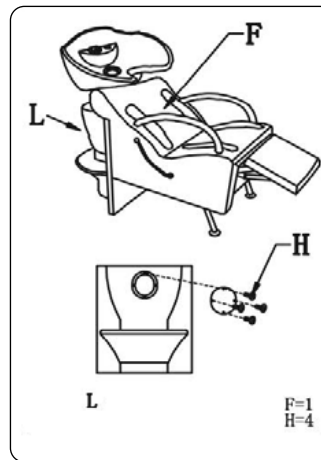
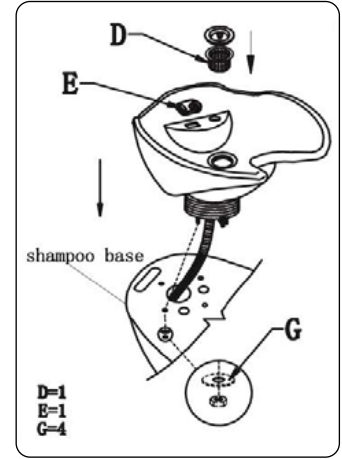
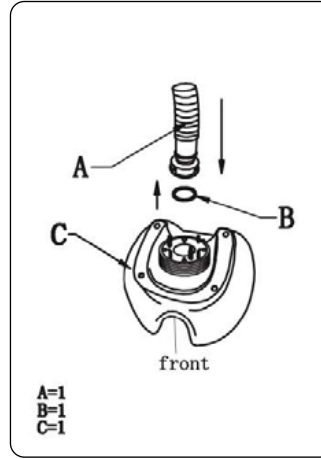

Note: This is a general schematic. Some models may vary.

### Note:

1. All plumbing needs to be installed, sealed, and assured by a licensed plumber. SkinAct/Spa and Equipment is not responsible for liabilities regarding plumbing, sealing, or maintenance of such equipment.

2. If the shampoo bowl is not aligned with the base, drilling or expansion of the fiberglass may be required.

# Highlights

## Features:

- Porcelain tilting bowl
- Faucet
- Soft spray hose
- Silicone neck rest
- Drain assembly w/ strainer
- Arched back-rest for extra comfort

\*\*\* Optional Vacuum Breaker available \*\*\*

## Detailed Unit Dimensions:

- Length from back to front: 45"
- Width of the seat: 19"
- Width of the seat with arm rests: 27"
- Height from the ground to the top of the bowl: 41"
- Height from the ground to the top of the seat: 19"
- Bowl interior: L = 18.5" / W = 15"

## Note:

All the shampoo chairs, shampoo bowls, pedicure chairs and equipment that has plumbing needs to be installed, sealed, and assured by a licensed plumber. SkinAct/Spa and Equipment is not responsible for liabilities regarding plumbing, sealing, or maintenance of such equipment.