

SKIN+ACT

5 in 1 Skin Care System (Vacuum, Spray, High- Frequency, Facial Brush, Galavnic)

PRODUCT MANUAL

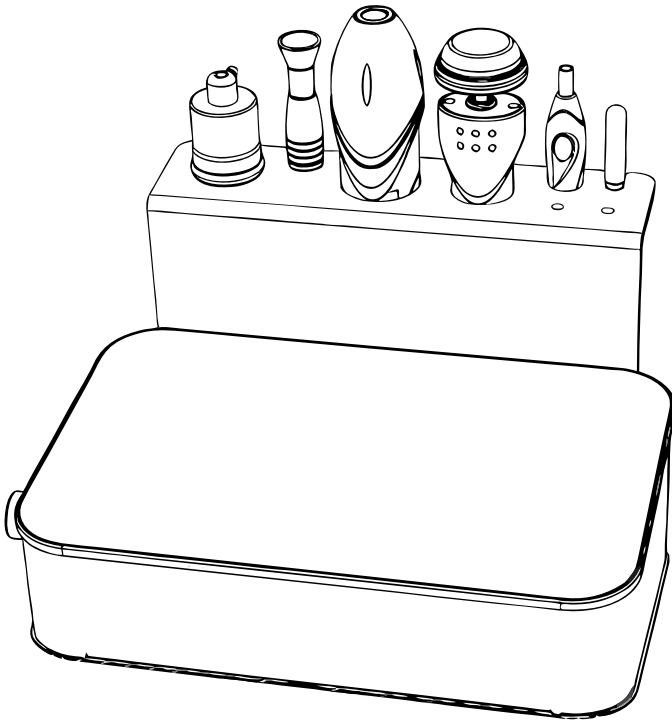

NOTICE

No part of this document may be photocopied, reproduced, or translated into any other language without prior written consent of Spa and Equipment/SkinAct.

The information in this document is subject to change without notice at any time and should not be construed as a commitment by Spa and Equipment/SkinAct.

Spa and Equipment/SkinAct assumes no responsibility for any errors that may be in this document, nor does it make expressed or implied warranty with regard to this material, including, but not limited to, the implied warranties of merchantability and fitness for a particular purpose.

Spa and Equipment/SkinAct shall not be liable for incidental or consequential damages arising out of the furnishing, performance, or use of this document and the program material which it describes.

Thank You For Purchasing This Product!

Please read the entire instruction manual carefully before using the product. Take note of any warnings included in this manual.

Always keep this instruction manual handy and if you give the device to another person, hand over the manual as it is an essential part of the product.

Some components of the product may differ from the image that appears in catalogues, websites, brochures, ect..

In order to enhance the product, the manufacturer reserves the right to modify its features and/or components without prior notice.

TABLE OF CONTENTS

Brush Cleansing Function - Operating Instructions 26

Replacing the Brush Head 27

Brush Cleansing: Precautions 28

Galvanic Introduction: Operating Instructions 29

Ion Polarity 29

How To Use (Galvanic) 30

Important Notes 32

Daily Maintenance 33

Specifications 34

Warranty Information 35

TABLE OF CONTENTS

Disclaimer & Contraindications	5
Precautions & Safety Instructions	6
Probe Safety & Handling	7
Included Items	8
Device Components	10
Accessories to Spray & Vacuum	11
High Frequency Tool Components	12
Brush Handle Components	13
Galvanic Tool Components	14
Device Components (Interface)	15
Device Assembly & Touch Control Operation	16
Vacuum Function - Operating Instruction	17
Vacuum Tips Attachments & Spray Function	18
Vacuum & Spray Precautions	19
High-Frequency Electrotherapy Function	21
Glass Electrotherapy Tubes	21
How to Use (Direct Electrotherapy)	22
How to Use (Indirect Electrotherapy)	23
Important Notes (Electrotherapy)	24
Daily Maintenance (Electrotherapy)	25

DISCLAIMER

- This product has been designed to be used by esthetic professionals at spas and salons, it should not be used for other purposes.
- Please note that any misuse of the device entails the loss of the guarantee.
- Do not make any modification to the device without the authorization.
- We shall not be held liable for any material or personal damage due to the misuse of the product.
- Documents are made available without warranty of any kind. They may be updated, altered, expanded, or removed at any time. Skin Act does not warrant or guarantee any of the processes described herein or perform any independent analysis in connection with guidelines provided.
- Readers are expressly warned to consider and adopt all safety precautions indicated herein and to avoid all potential hazards. By following the instructions provided, the reader willingly assumes all risks in connection with such instructions.
- If the reader has questions about any of the guidelines provided by SkinAct we recommend they contact their nearest Esthetician Training Center to obtain more explicit instruction on Facial Machine Usage.

Contraindications

THIS DEVICE SHOULD NOT BE USED ON CLIENTS WITH:

- Pacemakers, metallic implants, or other electronic medical devices.
- Heart conditions or a history of heart disease.
- Pregnancy.
- Inflamed, irritated, or damaged skin.
- Severe acne rosacea or vascular conditions.
- Epilepsy or other seizure disorders.
- Clients undergoing medical treatments or with underlying health conditions must obtain prior clearance from a physician.

Precautions

- **Inspect the Device:** Check for any visible damage to the device or its power cable before and after each use.
- **Unplug When Not in Use:** Always disconnect the device from the power source before cleaning, storing, or performing maintenance.
- **Avoid Humidity:** Do not operate the device in bathrooms or other excessively humid environments.
- **Position Cables Safely:** Ensure the power cable is positioned to prevent tripping hazards and is plugged into a grounded socket.
- **Keep Away from Children:** The device and its accessories should be stored securely out of reach.
- **Report Issues Promptly:** If you notice abnormal functioning, contact your distributor or an authorized technician immediately.









Safety Instructions



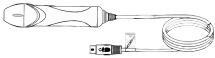



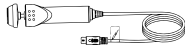
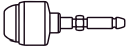

- Plug the device into a properly grounded electrical outlet with the appropriate voltage.
- Do not use the device if it or its power cable is damaged.
- Never touch the device, power plug, or cables with wet hands.
- Avoid attempting to repair or modify the device. Repairs should only be performed by authorized technicians.
- Store the device in a cool, dry place away from direct sunlight and moisture.

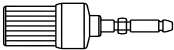
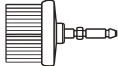
Probe Safety & Handling

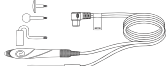
- **Continuous Output:** Do not leave the probe in an active output state without performing treatment, as this may cause overheating and reduce its lifespan.
- **Disassembly:** Do not attempt to separate the stainless steel probe from the handle, as this may damage the device.
- **Cleaning:** Do not clean the probe in water or use alcohol on metal components, as this may cause damage.
- **Surface Condition:** Do not use probes with damaged surfaces or severe scratches. Replace any compromised attachments immediately.
- **Malfunction:** If any abnormalities occur, stop use and contact a qualified technician. Do not attempt to open or repair the device yourself.
- **Environment:** Do not use the device in bathrooms or damp environments.
- **Storage Safety:** Keep the device away from flammable or explosive materials.

Included Items

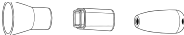
Qty	Part Name	Image
1	5 in 1 Skin Care System Unit	
1	Accessory Rack	
1	High Frequency Electrotherapy Wand	
1	Mushroom Electrode	
1	Spoon-Shaped Electrode	
1	Dot Electrode	
1	Straight Electrode	
1	Brush Handle	
1	Crystallized Small Brush	
1	Crystallized Large Brush	

Qty	Part Name	Image
1	Small Bristle Brush	
1	Large Bristle Brush	
1	Plastic Bristle Brush	
1	Shag Big Brush	
1	Roller Probe	
2	Spray Bottle	
1	Vacuum Handle	
1	Spray Hose Tube	
1	Vacuum Hose Tube	
1	Vacuum Tops	
1	Power Cable	

Device Components

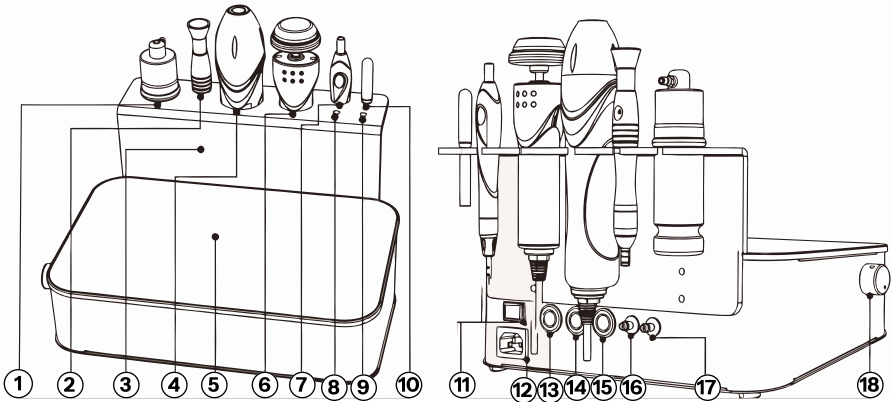

- 1. Spray Bottle
- 2. Vacuum Handle
- 3. Attachment Rack
- 4. High-Frequency Electrotherapy Handle
- 5. Control Panel
- 6. Brush Handle
- 7. Galvanic Handle
- 8. Galvanic Round Probe
- 9. Galvanic Sphere Probe

- 10. Galvanic Accessories
- 11. Power Switch
- 12. Power Outlet
- 13. Galvanic Output Interface
- 14. Brush Output Interface
- 15. High-Frequency Electrotherapy Output
- 17. Spray Output
- 18. Adjustment Knob

Accessories to Spray & Vacuum

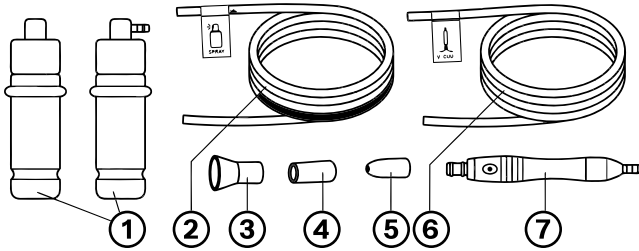

- | | |
|-----------------------|---------------------|
| 1. Spray Bottle | 5. Round Vacuum Tip |
| 2. Spray Tube | 6. Vacuum Tube |
| 3. Trumpet Vacuum Tip | 7. Vacuum Handle |
| 4. Flat Vacuum Tip | |

Vacuum

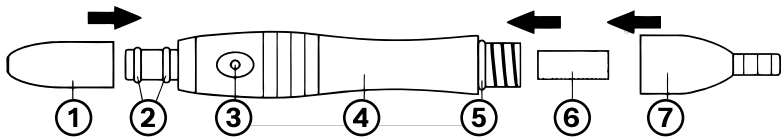

- | | |
|----------------------------|------------------------|
| 1. Round Vacuum Tip | 7. Seal Ring of Handle |
| 2. Seal Ring of Vacuum Tip | 8. Sponge Filter |
| 3. Air-Pressure Vent | 9. Vacuum Handle End |
| 4. Vacuum Handle | |

High Frequency Tool Components

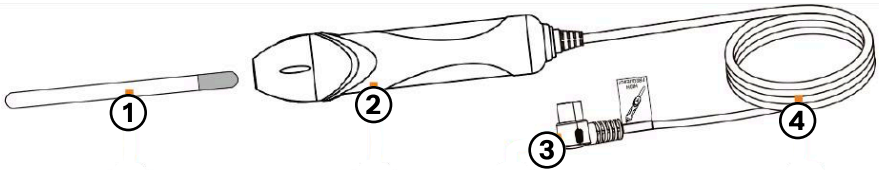

- | | |
|--------------------------|--------------------|
| 1. Electrotherapy Tube | 3. Plug for Handle |
| 2. Electrotherapy Handle | 4. Flexible Cable |

Selecting The Right Glass Electrotherapy Tube

- **Mushroom Shape:** Used for larger areas (Face & Neck)
- **Spoon Shaped:** Used for medium areas
(Nose & Jawline)
- **Dot Shape:** Used for small localized areas (Blemishes)
- **Rod Electrode:** Used for general & contour application areas

Assembly and Disassembly of the Electrotherapy Tube

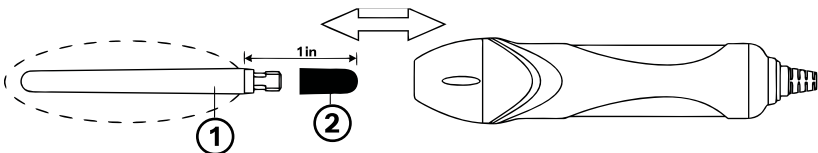

1. Glass Electrode
2. Metal Electrode

Instructions:

- When assembling or disassembling the electrotherapy tube, hold only the areas indicated by the dotted line.
- Keep your hand at least 30 mm away from the metal electrode at all times

Brush Handle Components

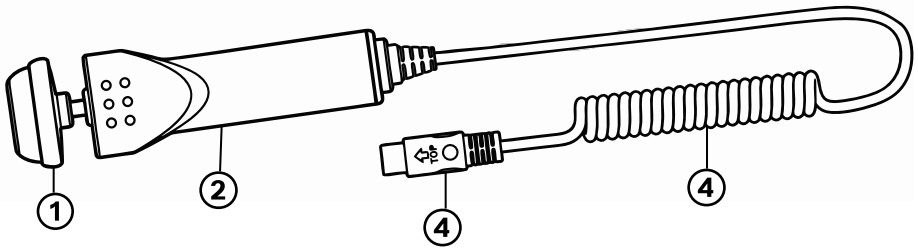

- | | |
|-----------------|--------------------|
| 1. Brush Head | 3. Plug for Handle |
| 2. Brush Handle | 4. Flexible Cable |

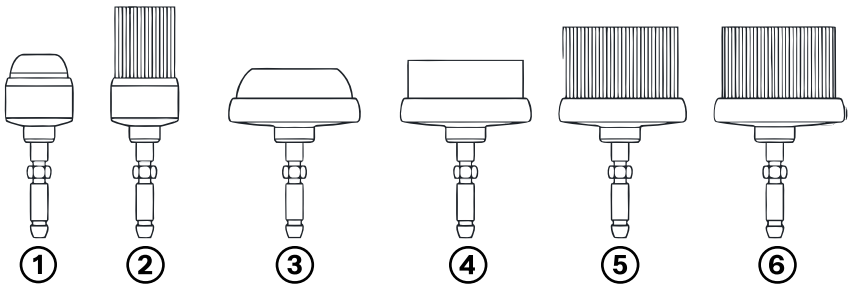

- 1. Crystallized Small Brush:** Used to clean small areas of hardened skin and calluses on the hands and feet.
- 2. Small Bristle Brush:** Suitable for gentle cleansing and massage of small facial areas.
- 3. Crystallized Big Brush:** Designed for cleaning larger areas of hardened skin and calluses on the hands and feet.
- 4. Plastic Bristle Brush:** Ideal for cleansing and massaging larger areas of the face.
- 5. Large Bristle Brush:** Provides gentle cleansing and massage for larger facial areas.
- 6. Shag Big Brush:** Used for cleansing and massaging larger areas of the face and other body areas.

Galvanic Tool Components

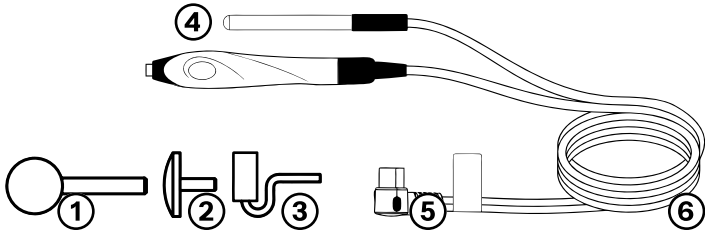

- 1. Round Eye Probe
- 2. Galvanic Sphere
- 3. Roller Probe
- 4. Conduction Probe
- 5. Conduction Probe Plug
- 6. Conduction Probe Cable

Vacuum Function- Operating Instructions

- **Function Activation:** Select the vacuum icon on the control panel. The indicator light will turn on to confirm activation.
- **Suction Adjustment:** Use the adjustment knob to control suction strength. Turn left to decrease suction and right to increase suction.
- **Time Setting:** Use the increase and decrease buttons to set the treatment time (1–30 minutes), then press the start/pause button to begin.

How to Use

- **Positioning:** Hold the suction wand like a pen and place the suction head gently against the skin.
- **Activation:** Use your finger to partially cover the pressure relief hole to activate suction.
- **Technique:** Move the wand slowly across the treatment area. Impurities such as blackheads and debris will be extracted.
- **Customization:** Select different suction heads depending on the treatment area.

Device Components (Interface)

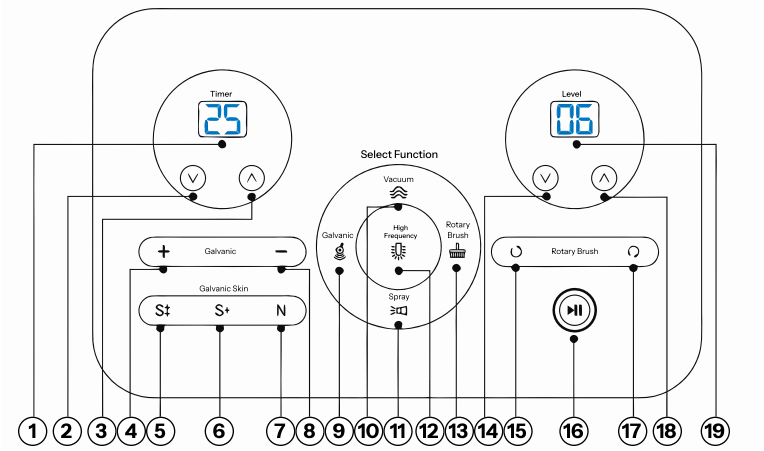

- | | |
|--------------------------|---------------------------|
| 1. Time display | 11. Spray Button |
| 2. Decrease Timer | 12. High-Frequency Mode |
| 3. Increase Timer | 13. Brush Mode |
| 4. Cation Mode Indicator | 14. Decrease Energy Level |
| 5. Ultra-Sensitive Mode | 15. Brush Rotate (CCW) |
| 6. Sensitive Mode | 16. Start/Pause Button |
| 7. Normal Mode | 17. Brush Rotate (CW) |
| 8. Anion Mode Select | 18. Increase Energy Level |
| 9. Galvanic Mode | 19. Energy Display |
| 10. Vacuum Mode | |

Assembly Instructions

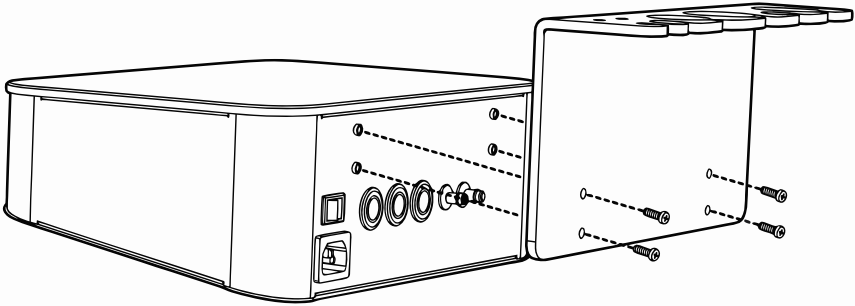



- 1. Attach the Rack:** Secure the attachment rack to the back of the main unit using the provided screws, following the direction of the arrows.
- 2. Place Attachments:** Place each attachment onto the rack.
- 3. Connect Attachments:** Plug all handles into corresponding output ports on the back of the main unit. Handles will not work unless attached to the correct interface.

Touch Control Operation

- **Function Selection:** This device uses touch-sensitive buttons. Tap the corresponding icon to select the desired function.
- **Time & Energy Adjustment:** In standby mode, use the increase and decrease buttons to adjust treatment time and energy level.
- **Start/Pause:** Press the start/pause button to begin or stop the operation.

Vacuum Tip Attachments

<p>Small Round Head: Suitable for blackheads and whiteheads on targeted areas.</p>	
<p>Flat Head: Suitable for narrow or hard-to-reach areas.</p>	
<p>Trumpet Head: Suitable for larger areas of the skin.</p>	

Spray Function- Operating Instructions

- **Function Activation:** Select the spray icon on the control panel. The indicator light will turn on to confirm activation.
- **Time Setting:** Use the increase and decrease buttons to adjust the treatment time (1–30 minutes).
- **Start/Pause:** Press the start/pause button to begin or stop the operation.

How to Use

- **Preparation:** Ensure the spray bottle is properly filled and securely attached before use.
- **Operation:** Hold the spray bottle firmly and gently press the air hole at the top to release a fine mist.
- **Switching Bottles:** If using multiple solutions, pause the device before switching spray bottles.
- **Application Technique:** Spray evenly across the face, starting from the forehead and moving downward while maintaining a safe distance from the skin.

- **Sensitive Areas:** Avoid direct spraying into the eyes, nose, and mouth. Ask the client to keep eyes and mouth closed during treatment.
- **Post-Treatment:** After spraying, pause the device and use cotton pads or soft tissue to absorb excess liquid from the skin.

Vacuum & Spray Function - Precautions

- **Hose Connection:** Ensure the air hose is connected to the correct outlet according to the label. Do not connect incorrectly.
- **Replacement Safety:** Pause the device before replacing the spray bottle or nozzle.
- **Hose Handling:** Do not bend the hose or block the air nozzle during operation, as this may damage the device
- **Damage Check:** If the hose is cracked or damaged, trim the affected area and reconnect securely to maintain proper performance.

Spray Function- Precautions

- **Hose Connection:** Ensure the air hose is connected to the correct outlet according to the label. Do not connect incorrectly.
- **Replacement Safety:** Pause the device before replacing the spray bottle or nozzle.
- **Hose Handling:** Do not bend the hose or block the air nozzle during operation, as this may damage the device
- **Damage Check:** If the hose is cracked or damaged, trim the affected area and reconnect securely to maintain proper performance.

Vacuum Function- Precautions





- **Skin Preparation:** Clean and soften the skin before using the vacuum function
- **Suction Control:** Use moderate suction. Excessive suction may cause bruising or skin damage. Test on your hand before use.
- **Duration Control:** Avoid prolonged suction in one area to prevent bruising.
- **Skin Type Consideration:** For oily skin, suction frequency may be increased. Avoid use on sensitive skin, dilated capillaries, inflamed areas, or around the eyes.
- **Frequency:** Do not overuse the vacuum function to prevent enlargement of pores.
- **Post-Use Cleaning:** Disassemble, clean, dry, and disinfect the suction tube after each use.
-

- **Filter Maintenance:** Replace the sponge filter regularly. Do not use the device without the filter, as this may damage the unit.

High-Frequency Electrotherapy Function

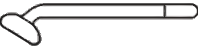
- **Function Activation:** Select the high-frequency icon on the control panel. The indicator light will turn on to confirm activation.
- **Time Setting:** Use the increase and decrease buttons to adjust the treatment time (1-30 minutes).
- **Energy Adjustment:** Use the increase and decrease buttons to set the energy level (1-9).
- **Start/Pause:** Press the start/pause button to begin or stop the operation.

Glass Electrotherapy Tubes

	<p>Mushroom Electrode: Used for larger areas (Face & Neck)</p>
	<p>Spoon Electrode: Used for medium areas (Nose & Jawline)</p>
	<p>Spot Electrode: Used for small localized areas (Blemishes)</p>
	<p>Rod Electrode: Used for general & contour application areas</p>

How to Use (Direct Electrotherapy)

- 1. Preparation:** Apply a skincare cream or mask to the treatment area. Hold the high-frequency handle correctly and ensure the device is set to the minimum energy level. Do not touch the glass electrode with your hands or allow it to come into contact with metal objects.
- 2. Initial Contact:** Place the glass electrode in contact with the skin before starting the device. Press the start button to begin operation.
- 3. Energy Adjustment:** Gradually increase the energy level to a comfortable intensity.
- 4. Application:** Glide the electrode slowly across the forehead, cheeks, nose, and chin, keeping continuous contact with the skin.
- 5. Operation:** Move the electrode smoothly and evenly across the treatment area to ensure consistent results.
- 6. Completion:** After treatment, reduce the energy level to the minimum, press the start/pause button to stop the device, and then remove the electrode from the skin.

Effects of Direct Electrotherapy

- **Soothing Effect:** Produces gentle warmth that calms and relaxes the skin.
- **Circulation Boost:** Promotes blood circulation and improves skin elasticity and radiance.
- **Cell Stimulation:** Enhances cell metabolism, supporting skin renewal and detoxification.
- **Absorption Enhancement:** Increases skin permeability, improving absorption of skincare products.

How to Use (Indirect Electrotherapy)

- 1. Preparation:** Have the client hold the straight electrode securely in their hand.
- 2. Start-Up:** Press the start button and gradually adjust the energy level to a suitable intensity.
- 3. Application:** The operator massages the client's skin while the client holds the electrode. Do not touch the electrode during operation.
- 4. Completion:** Before removing the electrode, press the start/pause button to stop the device.

Effects of Indirect Electrotherapy

- **Circulation Stimulation:** Enhances blood circulation and overall skin metabolism.
- **Skin Function Support:** Helps regulate and improve the skin's absorption and defense functions.
- **Cell Vitality:** Stimulates underlying skin cells, improving overall skin health.

Important Notes

- **Normal Operation:** The electrotherapy handle emits a continuous sound during normal use.
- **Spark Sensation:** Slight sparks may occur if the electrode is close to but not fully touching the skin, which may cause discomfort. Always start at the minimum energy level before contact. If sensitivity persists, place a dry gauze over the skin (as shown below).



- **Proper Contact:** Ensure the electrode maintains full contact with the skin during direct electrotherapy to avoid unwanted sparking.
- **Treatment Duration:** For oily skin, limit treatment to approximately 8 minutes. For dry or sensitive skin, reduce treatment time to 3–5 minutes. Adjust energy levels accordingly.
- **Indirect Technique:** During indirect electrotherapy, maintain consistent contact with the client to prevent interruption of the current.
- **Start Safety:** Always begin operation only after the electrode is in contact with the skin, then gradually increase the energy level.
- **Removal Procedure:** Before removing the electrode, reduce the energy level to minimum and turn off the device.

- **Installation Safety:** Turn off the power before installing or removing glass electrodes.
- **Hygiene:** Keep all electrodes clean, dry, and disinfected before and after each use.
- **Handle Cleaning:** Clean the handle with a dry cloth. Do not wash with water. If needed, use alcohol and store in a dry place.

Daily Maintenance

- **Handling & Disinfection:** Handle all glass electrodes with care and ensure proper cleaning and disinfection after each use.
- **Connection Check:** Regularly check that electrodes are securely connected. To test, insert the electrode into the handle, place it on a surface without contact, power on the device, and gradually increase the energy level. A visible glow indicates normal function.
- **General Cleaning:** Wipe the device regularly with a dry cloth and store it in a clean, dry, and well-ventilated area.
- **Moisture Protection:** Do not clean the device with water. Avoid exposure to moisture.
- **Power Safety:** After each use, turn off the main power switch and unplug the device.
- **Storage Conditions:** Store the device away from direct sunlight, rain, humidity, dust, and excessive smoke. Keep cables organized and untangled.

Brush Cleaning Function - Operating Instructions

- **Function Activation:** Select the brush icon on the control panel. The indicator light will turn on to confirm activation.
- **Rotation Direction:** Choose the rotation direction as needed. Use the clockwise or counterclockwise selection button based on treatment preference.
- **Time Setting:** Use the increase and decrease buttons to adjust the treatment time (1–30 minutes).
- **Energy Adjustment:** Use the increase and decrease buttons to set the energy level (1–9).
- **Start/Pause:** Press the start/pause button to begin or stop the operation.

Replacing the Brush Head

1. **Removal:** Hold the handle firmly with one hand and the plastic base of the brush head with the other. Pull gently in opposite directions until the brush head detaches.
2. **Installation:** Align the brush head with the handle and press firmly until it clicks into place.
3. **Handling:** Always grip the plastic base when removing or installing. Do not pull on the bristles, as this may damage the brush and affect performance.

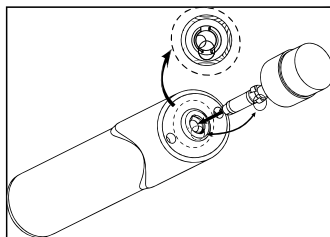

How to Use (Brush Cleansing)

- 1. Preparation:** Moisten the skin with water or use the spray function to dampen the treatment area
- 2. Product Application:** Apply a suitable cleansing product (such as cleansing milk or gel) evenly to the skin.
- 3. Brush Selection:** Choose an appropriate brush head for the skin type and treatment area, then attach it securely to the handle.
- 4. Start-Up:** Lightly dampen the brush head with distilled water, turn on the device, and begin cleansing.
- 5. Operation:** Move the brush gently across the skin in circular motions using light pressure. Keep the skin moist throughout the treatment.
- 6. Post-Cleansing:** After treatment, remove any remaining product with a towel or tissue. Then cleanse the skin again using a damp towel or cleansing pad.

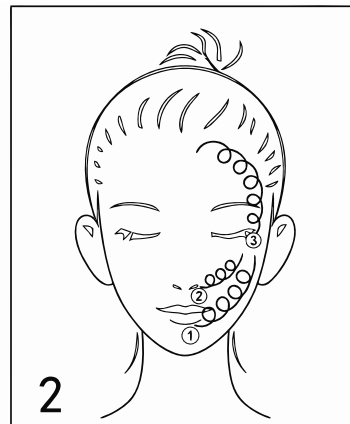
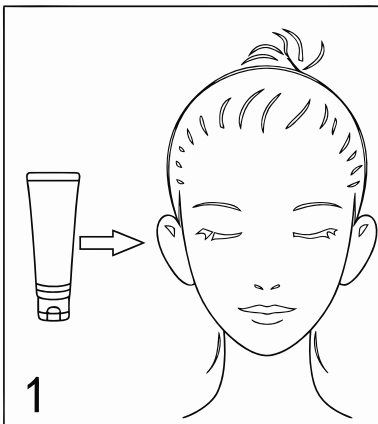

Brush Cleansing Function - Precautions

- **Attachment Check:** Ensure the brush head is securely attached before use.
- **Initial Contact:** Before the brush touches the skin, start at a lower speed. Use gentle pressure to avoid discomfort.
- **Product Use:** When using cleansing or massage products, reduce the rotation speed to prevent splashing or product dispersion.
- **Replacement Safety:** Pause the device and ensure the brush has completely stopped before replacing the brush head.
- **Cleaning After Use:** Remove and clean all brush heads after each use. Disinfect and store them in a dry place.
- **Handle Care:** Do not immerse the brush handle in water. Clean it with a dry cloth after use and store in a dry environment.

Galvanic Function - Operating Instructions

- **Function Activation:** Select the galvanic icon on the control panel. The indicator light will turn on to confirm activation.
- **Time Setting:** Use the increase and decrease buttons to adjust the treatment time (1-30 minutes).
- **Energy Adjustment:** Use the increase and decrease buttons to set the energy level (1-9).
- **Start/Pause:** Press the start/pause button to begin or stop the operation.

Ion Polarity Selection

- **Mode Switching:** Select the appropriate polarity based on the treatment goal.

+	Positive Ion Mode: Used for ion introduction (infusion) treatments.
-	Negative Ion Mode: Used for deep cleansing and impurity removal.

Skin Type Selection

N	Normal Skin(N): Used for ion introduction (infusion) treatments.
S⁺	Sensitive Skin (S): Used for deep cleansing and impurity removal.
S⁺	Very Sensitive Skin (S+): Used for deep cleansing and impurity removal.

How to Use (Galvanic Function)

A. Monopolar Infusion Method

- 1. Preparation:** Apply half of the skincare essence directly to the treatment area. Soak the remaining essence into a cotton pad and wrap it around the treatment probe.
- 2. Client Setup:** Set the energy level to minimum. Have the client hold the metal electrode rod, while the operator holds the probe and places it on the treatment area.
- 3. Start-Up:** Press the start button to activate the device. Select the appropriate ion polarity (+ or -), then gradually increase the energy level until a slight tingling sensation is felt
- 4. Application:** Move the probe slowly across the skin in circular, zigzag, or spiral motions while maintaining constant contact. Treatment time is typically 3–5 minutes.
- 5. Completion:** Press the start/pause button to stop the device. Remove the probe and have the client release the electrode rod.

B. Bipolar Infusion Method (Dual Roller)

- 1. Preparation:** Apply skincare product evenly to the treatment area or use a cotton pad soaked with product.
- 2. Setup:** Connect one roller to the positive pole and the other to the negative pole. Ensure the two rollers do not touch each other.
- 3. Start-Up:** Set the energy level to minimum, then press the start button. Select the appropriate ion polarity based on the product used.

4. **Energy Adjustment:** Gradually increase the energy level until a mild tingling sensation is felt.
5. **Application:** Glide the rollers smoothly across the skin. Move evenly across the face to ensure balanced treatment.
6. **Technique Note:** If only one roller is used at a time, alternate between positive and negative sides to ensure even coverage.

C. Double Ball Probe

1. **Application Area:** The double ball probe is suitable for small or irregular areas.
2. **Operation:** Follow the same steps as the bipolar (dual roller) method, adjusting movement for smaller, targeted areas.

D. Impurity Export (Deep Cleansing)

1. **Polarity Setting:** Set the working probe to negative (-) polarity. The client holds the positive (+) electrode rod.
2. **Preparation:** Soak a cotton pad with saline or impurity-removal solution and wrap it around the probe head, or apply a thin layer of gauze or mask to the treatment area.
3. **Start-Up:** Turn on the device and select negative ion mode. Begin at a low energy level and increase gradually.
4. **Application:** Move the probe slowly across the treatment area while maintaining full contact with the skin.
5. **Completion:** After treatment, reduce the energy level to minimum, stop the device, and remove the probe.

Important Notes (Galvanic Function)

- **Treatment Order:** Perform galvanic treatment after cleansing and exfoliation, but before massage. Ensure the skin is clean and dry.
- **Contact Medium:** Always wrap the probe with cotton or use a conductive medium to ensure proper current flow.
- **Energy Adjustment:** Increase energy gradually from low to a comfortable level, maintaining a mild tingling sensation.
- **Handling:** Do not touch the metal parts of the probe during operation.
- **Skin Type Consideration:** Suitable for dry, mature, and oily skin. Avoid heavy oil-based products, as they may reduce effectiveness.
- **Post-Treatment Care:** Clean the probe thoroughly after use and store it in a dry place.
- **Polarity Sensation:** Positive and negative modes may produce different sensations. Adjust according to comfort.
- **Metal Safety:** Remove all metal jewelry before treatment. Do not use on clients with metal implants or similar conditions.
- **Contraindications:** Do not use on sensitive, injured, inflamed, or compromised skin, or during pregnancy.
- The acidity or alkalinity of the nutrient solution must match the positive and negative poles of the roller.
 - When the roller is **positive (+)**, the nutrient solution should be **acidic (+)**.
 - When the roller is **negative (-)**, the nutrient solution should be **alkaline (-)**.

- During use, do not allow the metal parts of the roller or ball probe to come into direct contact with each other. If contact occurs, the device's protective mechanism will automatically activate. Separate the probes immediately to resume normal operation.
- Keep the probe clean at all times. Clean and disinfect after each use.
 - If using alcohol, only wipe the metal parts of the probe.
 - Do not clean other parts with alcohol, as this may cause damage.

Daily Maintenance

1. Arrange the connecting cable between the probe and device neatly. Avoid repeated twisting.
2. Handle the probe carefully during use. After use, disinfect and dry it thoroughly to keep it clean.
3. Clean the main unit with a dry cloth only. Do not use water.
4. After each use, turn off the main power switch and unplug the device before leaving it unattended.
5. Store the device in a location protected from direct sunlight, rain, humidity, dust, and excessive smoke.

Specifications

Product Name:	5 in 1 Skin Care System
Voltage:	AC100-120V/220-240V
Frequency:	50/60Hz
Power Consumption:	25W
Dimensions(L*W*H):	14.57x14.17x6.50 inches
Net Weight:	8.38 lbs

Warranty Information

The manufacturer (the “warrantor”) warrants to the original purchaser that this equipment will be free from defects under normal and proper operation for a period of one (1) year from the date of purchase. This warranty covers all parts and labor for that one (1) year period. This warranty shall not apply to any equipment that has been subjected to abuse, misuse and alteration of any type or to any defect or damage caused by repair, replacement, substitution, or use with parts other than parts approved by the manufacturer. The manufacturer shall not be liable for the loss of use of this equipment, loss of time or business, inconvenience or any other indirect, consequential, special or incidental damages due to defects covered by this warranty or any implied warranty. To implement this warranty, contact the dealer from whom you purchased the equipment. If necessary, you will be asked to return all, or the appropriate part, of the equipment. If warranted, the repairs will be performed at no charge and the equipment returned to you. Unit owner must prepay all shipping costs when returning items for warranty service. This limited warranty is the only written or express warranty given by the manufacturer. This warranty gives you specific legal rights but you may also have other rights, which may vary from state to state or province to province.

SKIN+ACT

Phone:1-800-418-0830

Email:info@skinact.com

Website:skinact.com