

SKIN+ACT

Luma Esthetician Stool

PRODUCT MANUAL

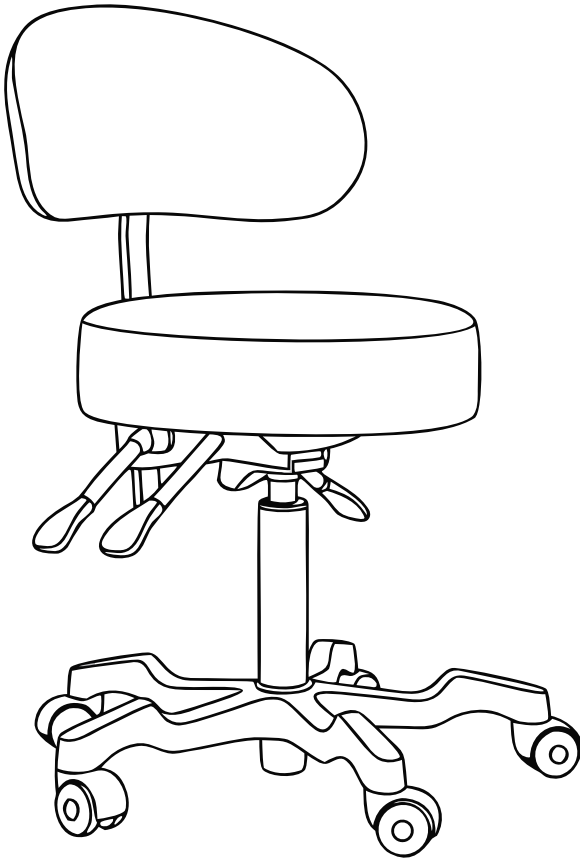

NOTICE

No part of this document may be photocopied, reproduced, or translated into any other language with out prior written consent of Spa and Equipment/SkinAct.

The information in this document is subject to change without notice at any time and should not be construed as a commitment by Spa and Equipment/SkinAct

Spa and Equipment/SkinAct assumes no responsibility for an errors that may be in this document, nor does it make expressed or implied warranty with regard to this material, including, but not limited to, the implied warranties of merchant ability and fitness for a particular purpose.

Spa and Equipment/SkinAct shall not be liable for incidental or consequential damages arising out of the furnishing, performance, or use of this document and the program material which it describes.

DISCLAIMER

- This product has been designed to be used by esthetic professionals at spas and salons, it should not be used for other purposes.
- Please note that any misuse of the device entails the loss of the guarantee.
- Do not make any modification to the device without the authorization.
- We shall not be held liable for any material or personal damage due to the misuse of the product.

TABLE OF CONTENTS

Specifications & Dimensions 4

Included Items 5

Assembly Instructions 5

Functions of the Stool 7

Maintaining Your Stool 8

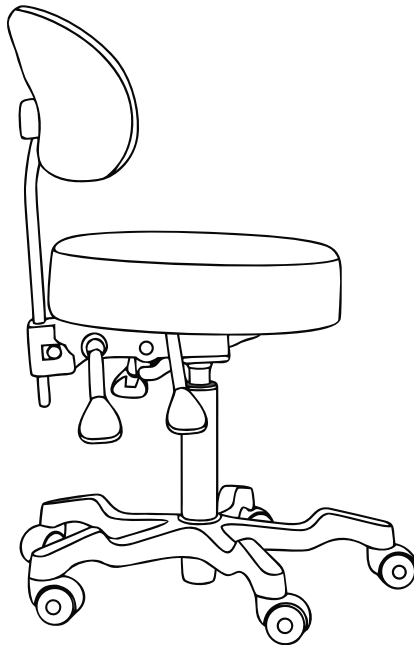

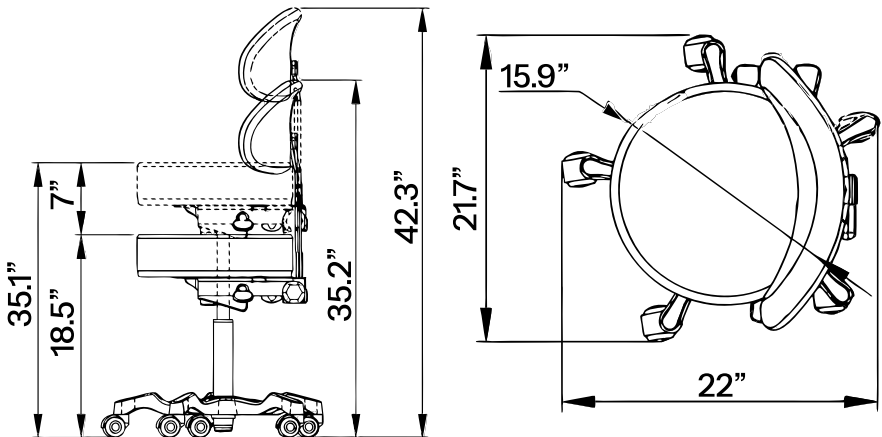

Specifications & Dimensions

- Net Weight: 23.15 lbs
- Packaging Gross Weight: 29.54 lbs
- Adjustable Height Range: 20 - 27 in.
- Seat Cushion Diameter: 15.9 in.
- Backrest Cushion Size: 18.5" W x 8.3" H
- Seat Cushion Thickness: 3.7"
- Maximum Weight Capacity: 330 lbs
- Padding Type: Sponge Foam
- Leather Type: PU/PVC

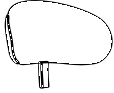
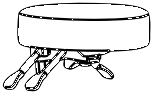
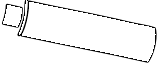

all measurements are in inches, please give a tolerance of .5" to 1"

Included Items

Qty	Part Name	Image
1	Backrest	
1	Seat Cushion	
1	Gas Spring	
1	Aluminum Alloy Base	
5	Wheel	

Assembly Instructions

1. Make sure you have all the parts needed to assemble your stool.
2. Start by installing the wheels into the aluminum base by pushing the castor wheel into the socket.
3. Take the gas spring and place it into the aluminum base.
4. Add the seat cushion on top of the gas spring and sit on it to lock the spring into place.
5. Lastly, slide the neck of the backrest into the slot of the seat cushion and tighten the knob till it is secure.

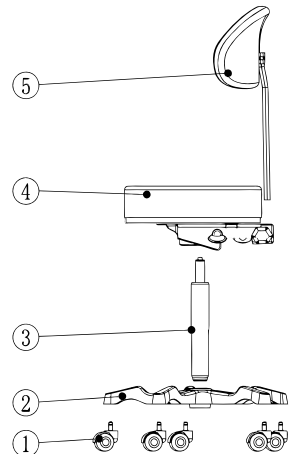

Functions of the Stool



1. Backrest Tilt Adjustment Handle
2. Height Adjustment Handle
3. Seat Cushion Tilt Adjustment Handle
4. Backrest Height Knob
 - a. Loosen the knob, adjust the backrest to your preferred height, then tighten to lock into place.

Maintaining Your Stool

1. Wipe loose dust and debris off of your stool with a dry towel.
2. Use a diluted sanitizing cleanser with a soft microfiber cloth to clean stains and marks off of the stool.
3. Caution: Using solvents including benzene, diluent or gasoline will damage the leather and/or cause corrosion to the product. Avoid these solutions when cleaning.
4. Avoid storing and using your stool in high moisture or heavy sunlight locations. This can result in damaging the stool physically.

Warranty Information

The manufacturer (the “warrantor”) warrants to the original purchaser that this equipment will be free from defects under normal and proper operation for a period of one (1) year from the date of purchase. This warranty covers all parts and labor for that one (1) year period. This warranty shall not apply to any equipment that has been subjected to abuse, misuse and alteration of any type or to any defect or damage caused by repair, replacement, substitution, or use with parts other than parts approved by the manufacturer. The manufacturer shall not be liable for the loss of use of this equipment, loss of time or business, inconvenience or any other indirect, consequential, special or incidental damages due to defects covered by this warranty or any implied warranty. To implement this warranty, contact the dealer from whom you purchased the equipment. If necessary, you will be asked to return all, or the appropriate part, of the equipment. If warranted, the repairs will be performed at no charge and the equipment returned to you. Unit owner must prepay all shipping costs when returning items for warranty service. This limited warranty is the only written or express warranty given by the manufacturer. This warranty gives you specific legal rights but you may also have other rights, which may vary from state to state or province to province.

SKIN+ACT

Phone:1-800-418-0830

Email:info@skinact.com

Website:skinact.com