

SKIN+ACT

Cleanpedi Lumi Pedicure Spa Chair

PRODUCT MANUAL



TABLE OF CONTENTS

| | |
|---|----|
| Notice & Disclaimer | 3 |
| Safety and Operating Instructions | 4 |
| Precautions | 4 |
| Electrical Requirement, Floor Level, Water Supply & Drain | 5 |
| Parts Included | 6 |
| Basin & Spa System Components | 7 |
| Spa System Components With Drain Pump (Optional) | 8 |
| Drain Pump (Optional) | 8 |
| Foot Bath Controls | 8 |
| Remote Control Instructions | 9 |
| Installation Instructions | 10 |
| Plumbing Installation | 12 |
| How to Fill Water into the Pedicure Spa Basin | 13 |
| Motor and LED Function | 13 |
| Water Removal From the Basin | 13 |
| Warning & Note | 14 |
| Cleaning Guide | 14 |
| Important | 15 |
| Specifications | 16 |

NOTICE

No part of this document may be photocopied, reproduced, or translated into any other language without prior written consent of Spa and Equipment/SkinAct.

The information in this document is subject to change without notice at any time and should not be construed as a commitment by Spa and Equipment/SkinAct.

Spa and Equipment/SkinAct assumes no responsibility for any errors that may be in this document, nor does it make any express or implied warranty with regard to this material, including, but not limited to, the implied warranties of merchantability and fitness for a particular purpose.

Spa and Equipment/SkinAct shall not be liable for incidental or consequential damages arising out of the furnishing, performance, or use of this document and the program material which it describes.

DISCLAIMER

This product is intended for professional use by trained spa, salon, esthetic, wellness, or other qualified professionals. It must be used only for its intended purpose and in accordance with all instructions, warnings, contraindications, maintenance requirements, and safety guidelines provided in this manual.

The information in this manual is for general product operation and safety reference only. It does not replace professional training, licensing requirements, medical advice, service instructions, applicable laws, or workplace safety rules. Users are responsible for proper training, safe operation, inspection, client screening when applicable, sanitation, maintenance, and compliance with all applicable regulations.

SkinAct/Spa and Equipment does not provide medical advice and does not diagnose, treat, cure, or prevent any disease, medical condition, injury, or skin disorder. Any treatment descriptions, suggested uses, or expected results are for general cosmetic and professional use reference only, and results may vary.

Before each use, inspect the product, power cord, accessories, attachments, moving parts, and related components, as applicable, for damage, looseness, contamination, instability, or abnormal operation. Do not use the product if it appears damaged, defective, improperly assembled, unsafe, or if any component is missing or malfunctioning.

The user assumes full responsibility for proper assembly, installation, operation, client selection when applicable, treatment technique when applicable, cleaning, maintenance, and storage. SkinAct/Spa and Equipment shall not be responsible for injury, property damage, treatment complications, equipment damage, loss of business, or other damages resulting from misuse, improper use, lack of training, failure to follow instructions, unauthorized repairs or modifications, improper maintenance, or use outside the intended purpose.

Do not modify, disassemble, repair, or alter this product unless authorized in writing by SkinAct/Spa and Equipment or performed by an approved service provider. Unauthorized modification, misuse, improper maintenance, or failure to follow this manual may void the warranty.

Product designs, specifications, components, accessories, images, and instructions may vary from the actual product and may be changed or updated without prior notice.

This product contains electric adjustment components and moving parts. Improper use may cause injury, pinching, equipment damage, or unsafe operation. Users are responsible for operating the table safely and following all instructions, warnings, and maintenance requirements in this manual. The user is solely responsible for confirming that use of this device is permitted under applicable state/local laws, scope-of-practice rules, licensing requirements, and workplace safety standards. This device is not intended for self-use, home use, or use by untrained individuals.

Safety and Operating Instructions

To ensure safe and proper operation of this pedicure chair please read the following instructions carefully and retain this manual for future reference.

- **Proper Setup and Grounding:**
- This electric pedicure chair is separated into two parts: the seat rest and the base. Each has a separate standard 3-prong plug to ensure grounding.
- **Avoid Water Exposure:**
- All plugs, buttons, and connecting cables must not come into contact with water or any other liquids during use.
- **Inspect for Damage:**
- Immediately discontinue use of the table if any plugs, buttons, or connecting cables are damaged.
- **Professional Repairs Only:**
- Repairs and maintenance must be conducted exclusively by trained and qualified professionals.

Precautions

Before installation, contact a qualified electrician and plumber to properly install the pedicure chair. The chair requires adequate electrical power, proper water pressure, safe water temperature, and a suitable drain connection to operate safely and efficiently.

Read all installation, electrical, plumbing, and safety instructions carefully before use to make sure all requirements are met.

Important:

1. Check the water temperature before each use. Water temperature should never exceed 100°F (38°C).
2. Always have clients enter and exit the pedicure chair slowly and carefully.
3. Do not bring or operate electrical devices near or inside the foot spa basin.
4. Do not stand in the whirlpool basin or foot spa tub.
5. Do not exceed the foot spa weight capacity of 250 lbs (113 kg).

Warnings:

Do not use the pedicure chair if the client has diabetes, poor circulation, inflamed skin, open wounds, swelling, fractures, fungal infections, or persistent foot or leg pain, unless approved by a physician.

Massage should always feel comfortable and relaxing. If the client experiences pain or discomfort, discontinue use immediately and advise the client to consult a physician.

Electrical Requirement

- The pedicure chair is equipped with a DC24V brushless pipeless jet motor and can operate on AC100V-240V, 50/60Hz power.
- A GFCI (Ground Fault Circuit Interrupter) must be used to supply power to the pedicure chair. Test the GFCI monthly by pressing the TEST button, then pressing the RESET button to confirm proper operation.

WARNING: A qualified electrician must connect the pedicure chair to the electrical supply. Improper installation may result in serious injury, death, or electrical shock.

Floor Level

- Place the pedicure spa on a level surface. The floor structure beneath the spa must be capable of supporting the unit safely.
- For proper clearance and chair movement, position the base of the pedicure spa approximately 25" to 28" from the back wall, depending on whether the chair base is manual or electric. If the distance is less than this, the chair may still recline, but the chair back may come into contact with the wall.











Water Supply

- The pedicure chair must be connected to a water supply that provides proper water pressure and temperature. All plumbing connections must comply with local plumbing codes.
- For safety and to protect the motor, the DC24V brushless motor will automatically shut off if there is not enough water in the tub. Once the tub has been filled to the proper level, press the SPRAY button again to restart the motor.
- Normal water pressure is required to fill the tub to the proper level. The water level must be above the jet cover before operating the jet motor.
- Water temperature should never exceed 100°F (38°C).

Water Drain

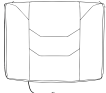
- Connect the pedicure chair drain system to the included drain pipe before draining water from the tub.
- If the chair is equipped with an optional drain pump, press the Drain button on the keypad to turn the drain pump on or off.

Parts Included

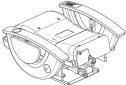
| Qty | Part Name | Image |
|-----|-----------------|---|
| 4 | Carriage Bolt |  |
| 6 | Washers |  |
| 4 | Nut Knob |  |
| 1 | Pivot Screw |  |
| 1 | Support Bracket |  |
| 1 | Foot Rest |  |
| 1 | Splash Guard |  |
| 1 | Bottom Cushion |  |
| 1 | Back Cushion |  |
| 1 | Head Cushion |  |
| 1 | Base |  |
| 1 | Seat Rest |  |

Basin Components

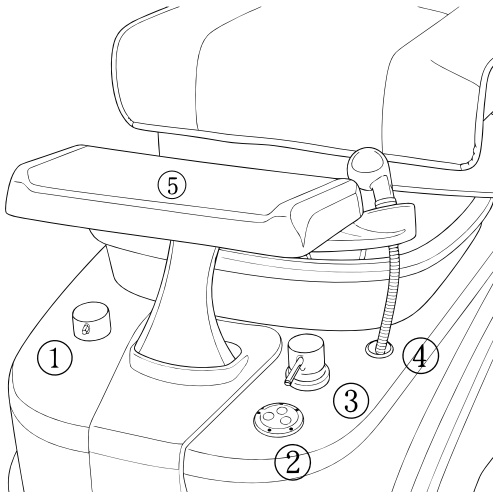

1. Foot Bath Drain Control
2. Foot Bath LED light Control
3. Spray Nozzle Hot/Cold, On/Off
4. Foot Bath Spray Nozzle
5. Adjustable Leg Rest

Spa System Components

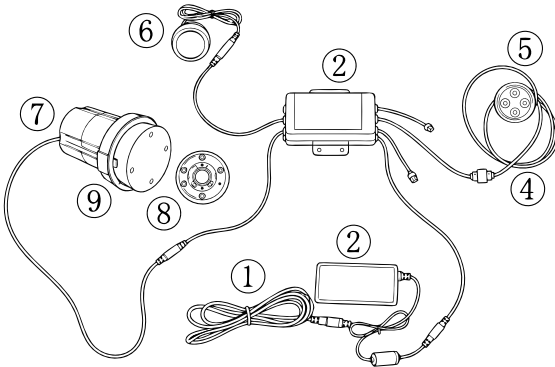

1. Power Cord
2. Power Switch
3. Spa Control Box
4. Keypad Signal Wire
5. 2 in 1 Keypad
6. DC12V LED light
7. DC24V Brushless Motor
8. Jet Assembly (wet end)
9. Motor Housing, etc.

Spa System Components With Drain Pump (Optional)

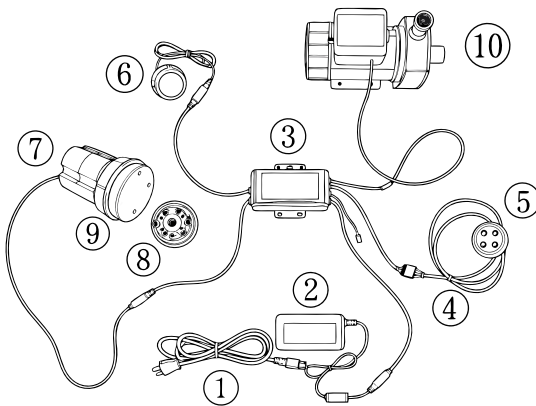

1. Power Cord
2. Power Switch
3. Spa Control Box
4. Keypad Signal Wire
5. 2 in 1 Keypad
6. DC12V LED light
7. DC24V Brushless Motor
8. Jet Assembly (wet end)
9. Motor Housing, etc.
10. Drain pump set

Drain Pump (Optional)

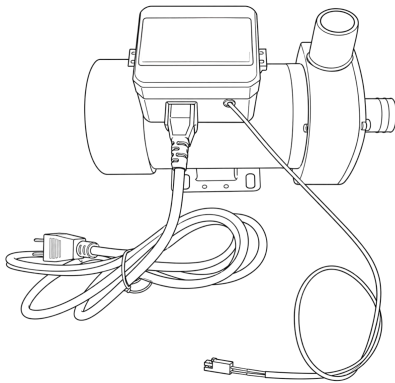

- AC ¼ HP Power Motor
- Signal wire connects with the spa control box
- One minute timer

Foot Bath Controls

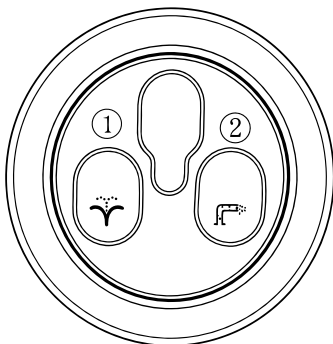

1. Jet/Light Button: Push to start or stop the jet motor and LED light.
2. Drain Button (Optional): Push to drain water if the spa system is equipped with a drain pump.

Remote Control Instructions



1. Massage Shoulder/Back/Waist Modes
2. Chair Position Forward/Backward
3. Chair Position Forward/Backward
4. Massage Rollers Position Up/Down
5. Massage Kneading Mode
6. Massage Tapping Mode
7. Massage Auto Mode
8. Massage Roller Mode (up/down)
9. Power On/Off
10. Set Massage Duration 10/20/30 min
11. Seat Vibration On/Off

Installation Instructions

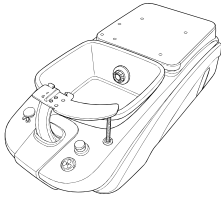

1. Place the base down in a clear open area.

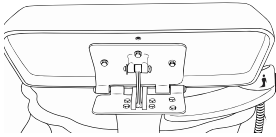

2. Using the pivot screw and support bracket, attach the footrest to the pedicure chair.

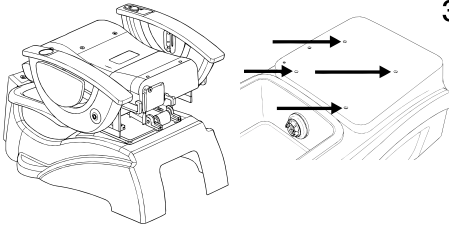

3. Place the folded seat onto the base and line up the four square holes with the base. **Do not lift the chair back upright during installation as this may shift the center of gravity and cause the chair to tip backwards.**

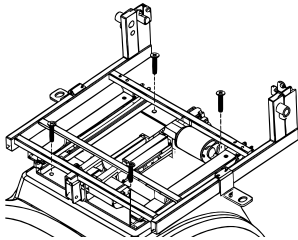

4. Align the 4 carriage bolts on the two crossbars reaching underneath the seat frame with the 4 holes on the top of the spa tub. After aligning the bolts, insert them through the holes.

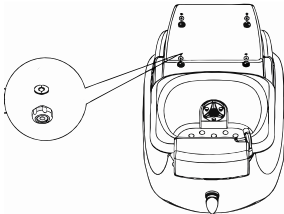

5. Secure the 4 carriage bolts with 4 washers and 4 nut knob screws. Tighten all nut knobs firmly to make sure the seat frame is securely attached.

Important: Make sure all screws are securely placed and tightened before using the chair.

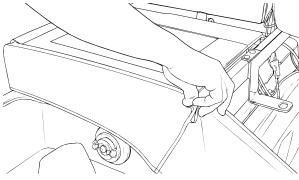

6. After confirming all screws are secure, push the seat rest into the proper sitting position and attach the splash guard to the Velcro on the seat rest base.

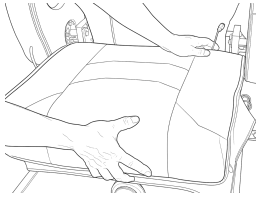

7. Attach the bottom cushion to the Velcro on the seat rest base.

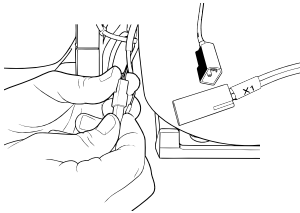

8. On the right side under the bottom cushion, connect the wire to the X1 wire connector on the base to set up the chair vibration feature.



9. Attach the back cushion to the Velcro along the seat rest.

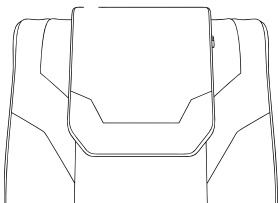

10. Lastly, attach the head cushion on top of the back cushion with Velcro on the back side of the seat rest.

For additional visual guidance, scan the QR code below to watch the full assembly video. Follow the video along with the written instructions in this manual to ensure proper setup.



Plumbing Installation

Installation must comply with all applicable local, state, and national building, plumbing, and electrical codes. Plumbing installation should be completed by a licensed plumber. All electrical wiring, components, and connections must be completed by a licensed electrician.

Plumbing Connection:

- All drain, hot water, and cold water connections must be completed by a qualified, licensed plumber in accordance with local plumbing and building codes.

Hot & Cold Water Supply:

- Carefully connect the ½" supply tubes to a fresh water source. The attached one-way valves should be used during installation.

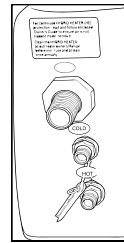

Testing the Pedicure

- Before using the pedicure spa, check that the jet cover is installed correctly. There is a triangle mark on the impeller housing and a raised point on the jet cover. When closing the jet cover, align these points so they are positioned at the 12 o'clock position, as shown in the image.
- The magnetic jet must be installed in the correct direction for the whirlpool to operate properly. If the jet cover is installed upside down, water may spray outside of the basin.

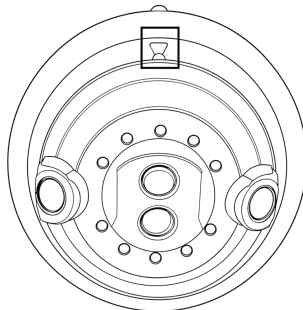

How to Fill Water into the Pedicure Spa Basin

1. Turn the drain handle until the drain stopper closes the drain opening.
2. Lift the hot and cold faucet handle upward to begin filling the basin.
3. Turn the faucet handle toward the cold or warm setting as needed.
4. Continue filling the basin until the water level is above the motor housing.

CAUTION: Always check the water temperature before use. Hot water can burn skin. Water temperature should not exceed 100°F / 38°C.

The pipeless jet motor will **automatically shut off** if there is not enough water in the basin. The magnetic jet system has a built-in 45-minute timer.

Motor and LED Function

1. Push the faucet handle downward to turn off the water.
2. Press the Jet/Light button to start or stop the jet motor and LED light.
3. Press the Drain button to drain water if the spa system is equipped with a drain pump.
4. Press the Auto Fill button to start auto-fill mode if the spa system includes this function.

Water Removal From the Basin

1. Before draining, make sure the spa jet motor and LED light are turned off using the keypad.
2. For use with a floor drain, open the drain by turning the drain knob clockwise until it stops. The water level should begin to lower as water exits the basin.

WARNING

- Do not turn the spa on unless the basin water level is above the jet cover. Operating the motor without enough water in the basin may damage the impeller and housing.
- Do not block the jets during whirlpool operation. Never drop or insert any object into any opening. Improper use may cause damage to the unit and may void the warranty.

Note

- Do not drain the basin until the jet motor has completely stopped operating.
- To drain the tub and plumbing system, turn the drain assembly to release the water. The system is designed to self-drain and should be drained after each use to help prevent stagnant water from remaining in the jet system.

Cleaning Guide

Proper care requires cleaning the basin after each customer and periodically flushing the magnetic jet system. How often the system needs to be flushed depends on the volume of use.

Do not use anything that may scratch, damage, or gouge the surface, as damaged areas can collect bacteria.

Follow the cleaning steps below:

1. Drain all water and remove any debris from the pedicure spa.
2. Clean the basin surface and walls with soap or a mild detergent.
3. Rinse thoroughly with clean water.
4. Wipe dry with a clean towel.
5. Remove the jet cover.
6. Wash the jet cover, impeller, housing, and cover inlet with soap or mild detergent and clean water.
7. Reinstall all parts securely before the next use.

IMPORTANT

The spa is made from high-quality material. Do not use acid-based or alkaline-based cleaning products. Do not scrub the surface with rough, sharp, or abrasive tools.

Clean and maintain the surface using a mild detergent and a soft sponge or cloth.

- For best results, we recommend cleaning with **SkinAct All-In-One Upholstery & Disinfecting Multi-Purpose Cleaner (SKU24261)**.

Specifications

| | |
|---|-----------------------------------|
| Product Name: | Cleanpedi Lumi Pedicure Spa Chair |
| Voltage: | 110V-120V |
| Frequency: | 60Hz |
| Power Consumption: | 72W |
| Total Height: | 54" |
| Total Length (Base): | 49" |
| Total Width (Base): | 14" |
| Open Bottom Base (L x W): | 43.7" x 19" |
| Drain Tube: | 47.2" |
| Footrest Width: | 15.5" |
| Open Back of Base (L x W): | 10" x 6.6" |
| Front edge of the tub base height: | 15" |

Specifications

| | |
|--|---------|
| Footrest Height (From floor to top of footrest): | 21" |
| Footrest Width: | 15.5" |
| Weight Capacity: | 300 lbs |

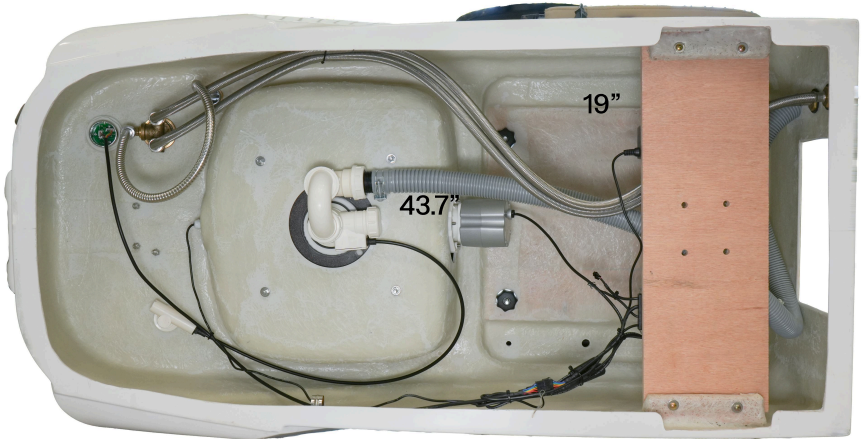

DRAIN PUMP SYSTEM OPTIONAL